

Elgin
USA

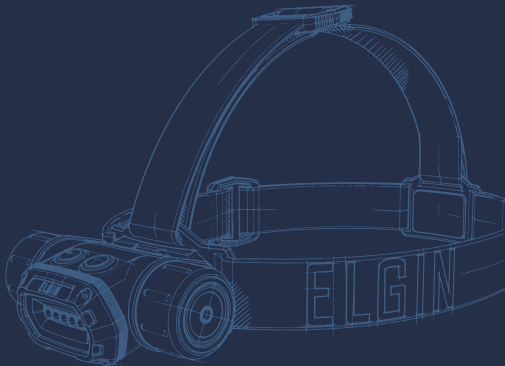

HELLDIVER

QUICK START GUIDE

A HERITAGE OF INNOVATION

You put your blood, sweat and tears into everything you do. Elgin products are made with that mantra in mind and more importantly, they are made for you.

We create tools that amplify the output of the everyday craftsman—the unapologetic, under-appreciated working class responsible for laying the brick & mortar of America. We believe there is no audience more inspiring or deserving to serve than this one, and it's our responsibility to enhance their workday with thoughtfully crafted products that combine cutting-edge tech with rugged & familiar designs.

Thank you for using the Elgin Helldiver headlamp.

Team Elgin

The logo features the word "Elgin" in a dark blue, cursive script font. Below it, the letters "USA" are written in a bold, red, sans-serif font.

WHATS IN THE BOX

Helldiver Unit

Headband

Zipper Case

Rechargeable Lithium-ion
Battery (Pre-installed)

Charger Wire

Wall Mount



Screws

User Guide

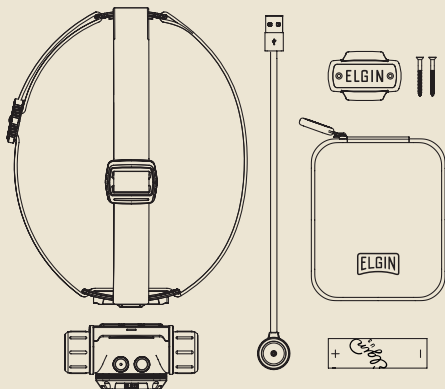
Warranty Card



SPECIFICATIONS

FL 1 STANDARD	ECO	LOW	MEDIUM	HIGH	RED LOW	RED HIGH
	3 LUMENS	20 LUMENS	100 LUMENS	600 LUMENS	20 LUMENS	100 LUMENS
	40h	30h	15h	6h	24h	8h
	<1m	5m	14m	34m	5m	13m
	<1 CD	7 CD	48 CD	281 CD	7 CD	41 CD

INGRESS PROTECTION RATING

Your Elgin Helldiver features an IP66 rated enclosure that protects against dust, sweat and water. The Helldiver is not designed for swimming or prolonged submersion in water. In case of submersion in water, quickly remove from water and air dry before use.



USING THE
HELLDIVER

CHARGING YOUR HELLDIVER

The rechargeable lithium-ion battery pre-installed in the Helldiver is partially charged out of the box. However, we recommend charging it fully before first use.

ATTENTION: Only use the supplied USB Magnetic cable to charge your Helldiver.

To charge the Helldiver, connect the provided charging cable to the magnetic charging port located on the bottom of the Headlamp.

The LED indicator will turn red while the Helldiver is charging. Once charging is complete, the LED indicator will turn green.

Approximate charge time is 3 hours.

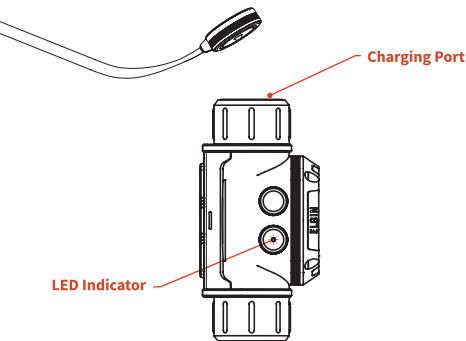

OPERATING THE HELLDIVER

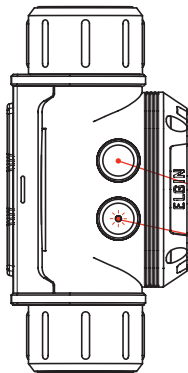

The Helldiver ships with the brightness level set to Eco. Press the Mode Button to cycle through each brightness level: Low, Medium, High, and Turbo.

Press and hold the Mode Button to switch to Red, Low and High. The Helldiver will default to the last used brightness mode.

Next Brightness Mode: Press the mode button.

Power On/ Off: Press the power button once.

Low Battery Reminder: When the battery level falls below 3%, the LED will flash red.

- ☀ Charging
- ☀ Fully Charged
- ☀ 100% to 40%
- ☀ 39% to 10%
- ☀ 9% to 4%
- ☀ 3% to 0%

REPLACING BATTERIES

All rechargeable batteries will eventually lose the ability to hold a charge. To replace the battery in the Helldiver:

Rotate the battery cap counterclockwise and remove to expose the battery.

Slide out the old battery.

Insert the new battery into the compartment positive end first.

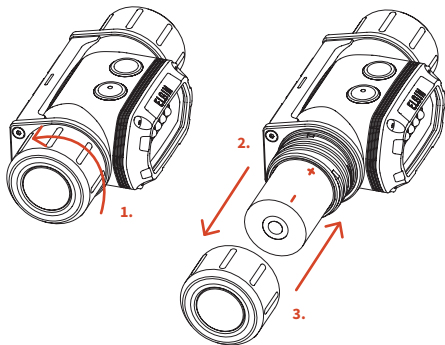

ATTENTION: We recommend only using Elgin-branded rechargeable lithium-ion batteries in the Helldiver.

BATTERY SAFETY INFORMATION

Rechargeable lithium-ion batteries can EXPLODE, CATCH FIRE, and/or CAUSE BURNS if disassembled, cut, crushed, short-circuited, punctured, or exposed to water, fire, or high temperatures.

DO NOT use any batteries advertised or promoted specifically for use in cameras or for other low-drain purposes in Elgin LED light products. Use only batteries labeled as safe to use in high-performance, high-drain devices that contain built-in fault and heat protection.

DO NOT put loose batteries in a pocket, purse, or other receptacle containing metal objects.

DO NOT store batteries with hazardous or combustible material. Always store in a cool, dry, ventilated area.

ALWAYS keep batteries away from children.

REPLACE ALL batteries at the same time and follow directions in the user manual for replacing batteries.

ONLY USE rechargeable batteries sold at ElginUSA.com as these rechargeable batteries are expressly for use in high-drain devices.

ONLY USE the charging cable or device that shipped with your product to charge rechargeable lithium-ion batteries.

In the unlikely event rechargeable batteries catch fire, DO NOT attempt to put the fire out with water—use a Class A, B, or C fire extinguisher.

Follow all applicable laws and regulations for transport, shipping, and disposal of batteries.

Failure to follow these warnings and/or directions could result in damage that may not be covered by Elgin's warranty.

HEADBAND ADJUSTMENT

Move the adjustment sliders on the headband to customize the fit.

The light unit is magnetized to the headband, for firm attachment ensure it is seated in the securing ridges.

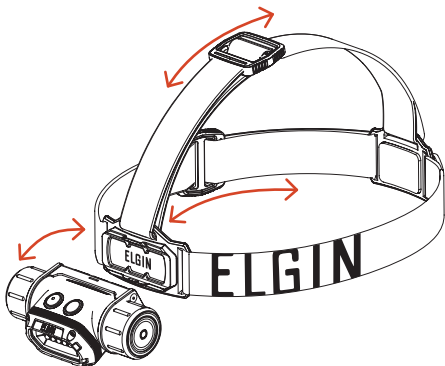

WALLMOUNT

Use the included screws to mount the wall mount station securely to a flat surface. Ensure the wire is routed in the top or bottom if you would like this to be a charging station.



SAFETY INFORMATION

DANGER! MAY CAUSE DAMAGE TO EYESIGHT. Directly looking at or shining the light into another person's eyes, may cause temporary blindness or irreversible eye damage.

DANGER! LITHIUM-ION BATTERIES ARE COMBUSTIBLE. Improper use or lack of maintenance could cause permanent damage to the Headlamp, property or inflict bodily injury.

CAUTION! HEADLAMP MAY GET HOT. Never touch the lens of the Headlamp or put it back in the storage case during or immediately after use.

NOTICE! Elgin USA is not liable for damage or injuries resulting from misuse, improper maintenance, or batteries and chargers incompatible with the Helldiver and its accessories.



CARE AND MAINTENANCE`

To clean the Helldiver use a damp cloth, with or without mild soap, to gently wipe away dust and dirt. Never use harsh or abrasive cloths or cleaners on any part of the Helldiver.

CONTACT US

For questions or information regarding the Elgin Helldiver or our other products, please contact us at support@elginusa.com, visit ElginUSA.com or scan the QR code on the right with your smart phone.



PARTS & ACCESSORIES

Genuine Elgin USA parts and accessories are available at ElginUSA.com/elgin-parts-accessories or simply scan the following QR code:



AMPLIFY YOUR
OUTPUT

ELGIN